

**New Products**

**CONTACT** No. 362

**NKK**  
SWITCHES  
*Innovation Driving Quality*

Light Touches for Smooth Operation

**Remarkable Endurance:  
10 million operations minimum**

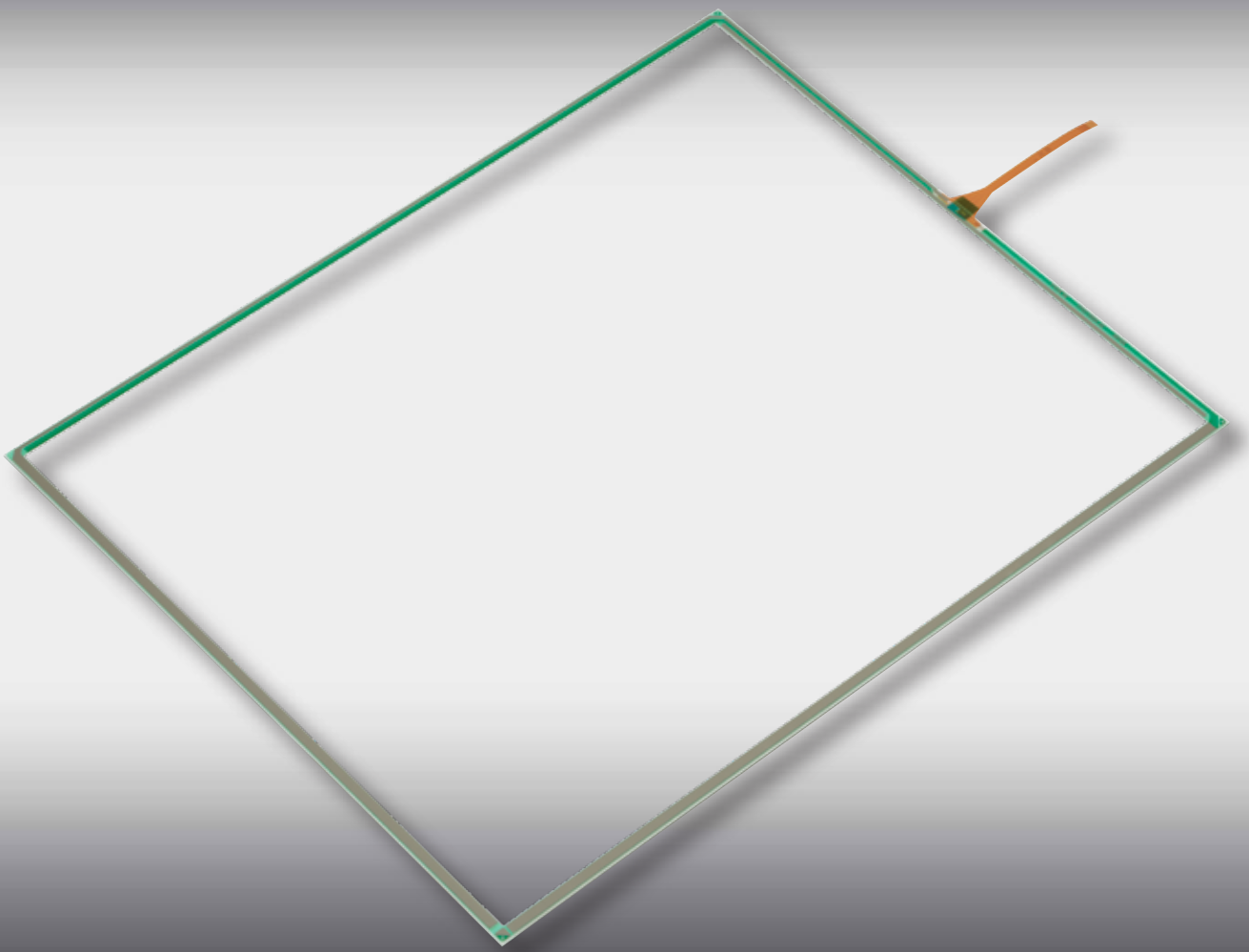

Series TP02

**4-Wire Analog  
Touch Screens**

**NKK SWITCHES CO., LTD.**

## Designed for **10 Million** Touch Inputs

### ☞ Remarkable Endurance

The TP02 series offers long service life for integration into devices intended for repeated use.

### ☞ Light Touches for Smooth Operation

Ensures reliable response to light touches with input pressure less than half that required by our previous product. The TP02 series assures reliable detection of touch operations, even when performed consecutively and quickly.

### ☞ Wide Variety of Compatible Screen Sizes

Analog: 10.4", 10.6" (Wide), 12.1", 12.1" (Wide), 15", 15.6" (Wide), 19"

### ☞ Improved Contact Stability

The new surface film material provides accurate, reliable tracing for work involving line drawings or similar work and assures uninterrupted, sensitive response.

### Standard Product (Film + Glass)

#### ☞ Wide Range of Input Methods

Our resistive film touch screens allow all kinds of input methods. Input is possible by finger or pen — even when wearing gloves.

#### ☞ Anti-Glare Surface Treatment

By applying an anti-glare treatment to the surface, reflection of fluorescent light is reduced.

#### ☞ Contains FPC Tail

A FPC tail is now included as a standard feature.

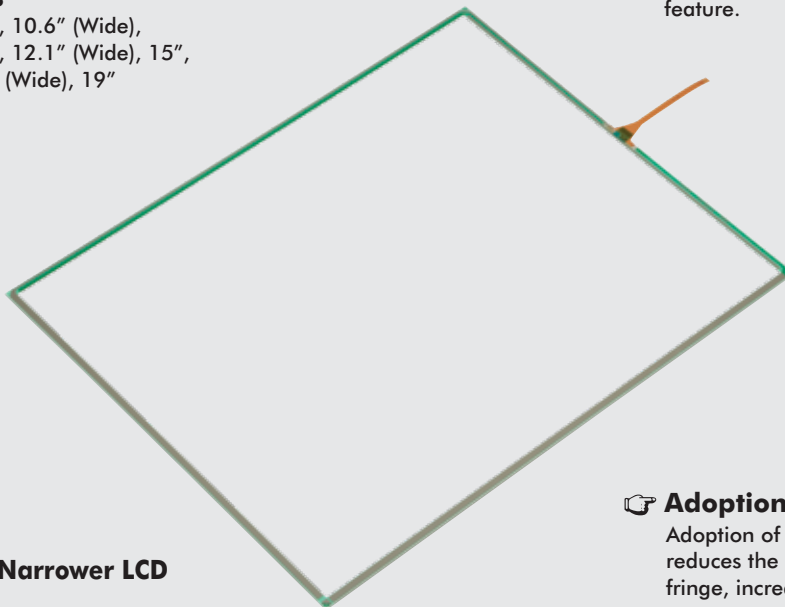

### ☞ Catering to Narrower LCD Frames

We've made the frames of our touch screens narrower so that they do not interfere with the design of narrow framed LCDs. (All sizes except 10.6" can be made with a narrow frame.)

### ☞ Adoption of Resistive Film Mode

The TP02 series are resistive film touch screens that take full advantage of transparent conductive thin film technology. Incorporating these films into a wide variety of display equipment such as LCD screens and plasma EL enables simple, interactive input operation even for people who do not have specialist technical or computer knowledge.

Touch screens are currently used in a wide variety of applications. Resistive films represent a high degree of freedom for input methods (digital, analog), size, and design at a relatively low cost.

#### ☞ Adoption of ANR Film

Adoption of ANR (Anti Newton-Ring) film reduces the occurrence of interference fringe, increasing visibility of the screen.

#### ☞ Hard Coating

Our hard coating (hard resin coating) provides superb protection to the surface of the films against scratches and damage from fingers and input pens (stylus).

#### Control Boards

Combining an analog touch screen with a control board device driver on a computer enables you to perform the same operations as you would with a mouse simply by touching the touch screen.

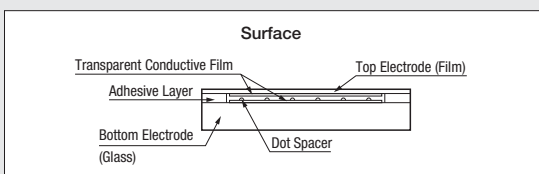

**New Control Board for Single Touch Screens!**

**Improved Sensitivity for Lighter Touches and Smoother Operations**

This newly introduced control board for single touch screens makes operating the TP02 series smooth and comfortable. The new control board and TP02 screen combine perfectly for even smoother operation.

**Supports the latest versions of Windows OS (Windows 10).**

The control board supports Windows 7/8/10.

**Wide Variety of Compatible Screen Sizes**

Analog: 10.4", 10.6" (Wide),  
12.1", 12.1" (Wide),  
15", 15.6" (Wide),  
19"

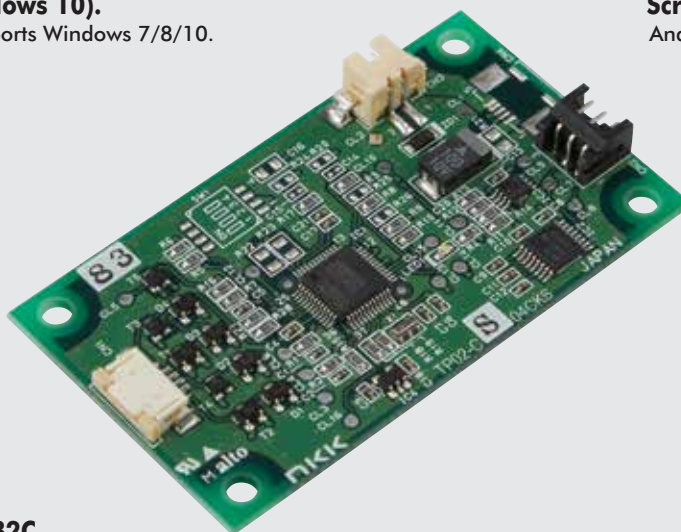

**Supports USB/RS232C**

\* Control boards for multi-touch functionality are also available. For more information, please contact our sales office.

**Flexible Compatibility for a Wide Range of Requirements**

Customized Products (Resistive film method)

The size of resistive film products can be **adjusted according to your needs**, even down to palm-sized products.

Can be incorporated into peripheral devices or **attached to LCDs**.

The **material composition can be adjusted according to use**, such as film + film.

A surface sheet (OCA/double-sided tape) can be attached to the touch screen. (OCA: Optical Clear Adhesive)

**A wide range of films** such as fingerprint-resistant and high transmittance films are also **available**.

**Input methods** such as pen input or finger input **can also be specified**.

## ► General Specifications

4-Wire Analog Touch Screens		
Power level	1 mA 5.5 V DC (Resistive load)	
XY Resistive Value	250–850 Ω (Wide type: 120–1,500 Ω)	
Linearity	± 1.5% maximum	
Insulation Resistance	10 MΩ minimum @ 25V DC	
Expected Operating Life	Writing	50,000 maximum operations (approximately 30 mm movement with stylus)
	Tapping	10,000,000 operations minimums (using 60°silicone rubber)
Touch Activation Force	0.02–1 N maximum	
Chattering Time	10 milliseconds maximum	
Relative Humidity	+40°C, 90% relative humidity, 240 hours (no condensation)	
Operating Temperature Range	-20 – +70°C	
Storage Temperature Range	-40 – +80°C	
Light Transmission	80% (TYP.) (Touch screen section)	
Surface Hardness	3H or harder (JIS K5400) (Pencil hardness)	

Each rated value/performance value is obtained through independent testing. Therefore, the same results are not guaranteed under complex conditions. Please refer to General Specifications page in General Catalog "Switch Guide" on specific models, ratings and ordering instructions.

## ► Applications

### •OA Systems

Various OA devices for input systems, building management systems, business administration systems, schedule management systems

### •FA Systems

Production process management systems, production system control, input systems for various manufacturing equipment, plant control systems

### •Communication Systems

Reception guidance systems, restaurant automation systems, POS systems, traffic systems

### •Banking Interface Systems

ATMs, cash dispensers, foreign exchange systems

### •Educational Systems

Home use/school education systems, audiovisual education systems, information processing education systems

### •Medical Systems

Medical chart management systems, medical data processing systems, physical treatment systems, bedside monitors

### •Entertainment Systems

## ► Typical Ordering Example

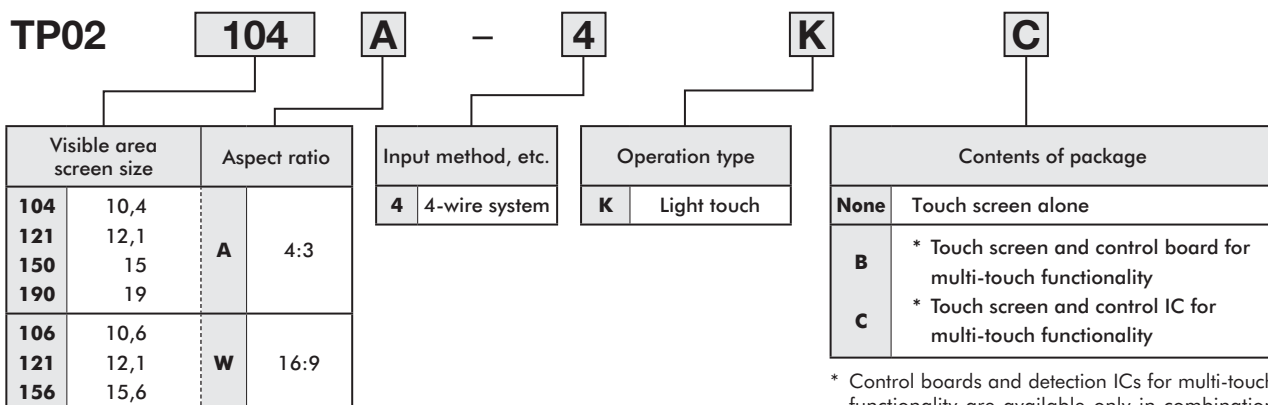

\* Control boards and detection ICs for multi-touch functionality are available only in combination with touch screens. For more information, please contact our sales office.

► Part Numbers & Descriptions

<b>TP02104A-4K</b>	<b>TP02106W-4K</b>	<b>TP02121A-4K</b>	<b>TP02121W-4K</b>
<b>TP02150A-4K</b>	<b>TP02156W-4K</b>	<b>TP02190A-4K</b>	

Part Number	Screen Size in Inches	Input Methods	Key Area Dimensions (mm)	Viewing Area Dimensions (mm)	External Dimensions (mm)	Screen Thickness (mm)	Terminal Detail
<b>TP02104A-4K</b>	10.4	Finger or input pen (stylus)	211.2×158.4	215×162.4	225.6×171.4	2.1	1 mm pitch 4 pin Length 80 mm
<b>TP02106W-4K</b>	10.6W	Finger or input pen (stylus)	230.4×138.2	233.4×141.3	247.8×154.8	2.1	1 mm pitch 4 pin Length 80 mm
<b>TP02121A-4K</b>	12.1	Finger or input pen (stylus)	245.8×184.3	249.6×188.1	260×198	2.1	1 mm pitch 4 pin Length 80 mm
<b>TP02121W-4K</b>	12.1W	Finger or input pen (stylus)	261.12×163.2	264.26×166.4	275×176	2.1	1 mm pitch 4 pin Length 80 mm
<b>TP02150A-4K</b>	15	Finger or input pen (stylus)	304.1×228.1	308.1×232.1	321.8×245.5	2.1	1 mm pitch 4 pin Length 77.7 mm
<b>TP02156W-4K</b>	15.6W	Finger or input pen (stylus)	344.2×193.5	347.5×196.8	362.6×214.2	2.1	1 mm pitch 4 pin Length 80 mm
<b>TP02190A-4K</b>	19	Finger or input pen (stylus)	376.3×301	382×307.4	395.5×321	2.1	1 mm pitch 4 pin Length 80 mm

► Sales Start Date

September 1, 2020

## ► General Specifications

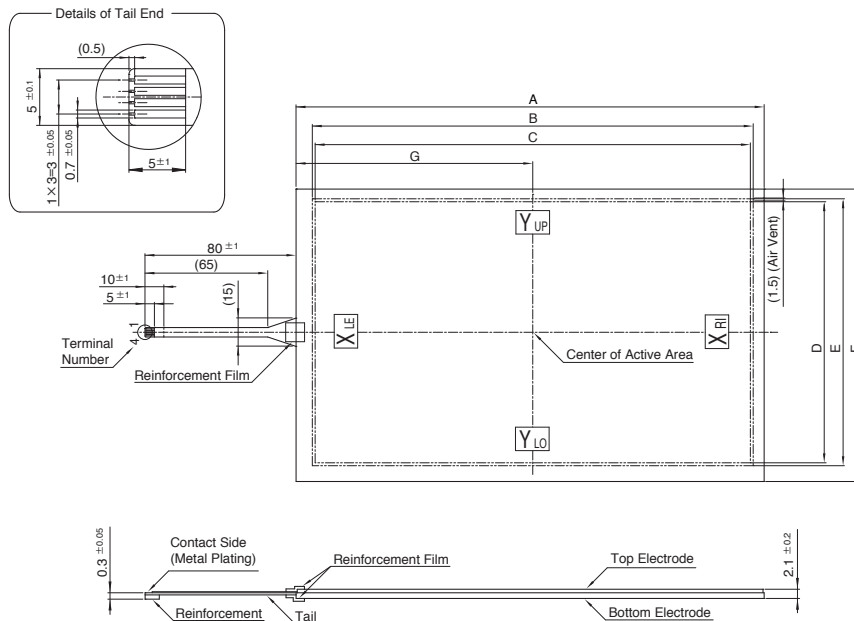

## Specifying circuit

Pins	Signal
1	Y <sub>UP</sub>
2	Y <sub>LO</sub>
3	X <sub>LE</sub>
4	X <sub>RI</sub>

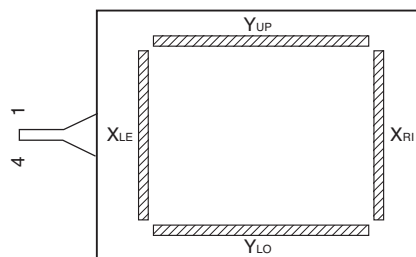

Y<sub>UP</sub>, Y<sub>LO</sub> : Bottom Electrode Contact  
 X<sub>LE</sub>, X<sub>RI</sub> : Top Electrode Contact

Model	Dimension A (mm)	Dimension B (mm)	Dimension C (mm)	Dimension D (mm)	Dimension E (mm)	Dimension F (mm)	Dimension G (mm)
TP02106AW-4K	247.8±0.3	233.4	230.4	138.2	141.3	154.8±0.3	125.3
TP02121AW-4K	275±0.3	264.26	261.12	163.2	166.4	176±0.3	138.89
TP02156AW-4K	362.6±0.3	347.5	344.2	193.5	196.8	214.2±0.3	181.3

## ► General Specifications

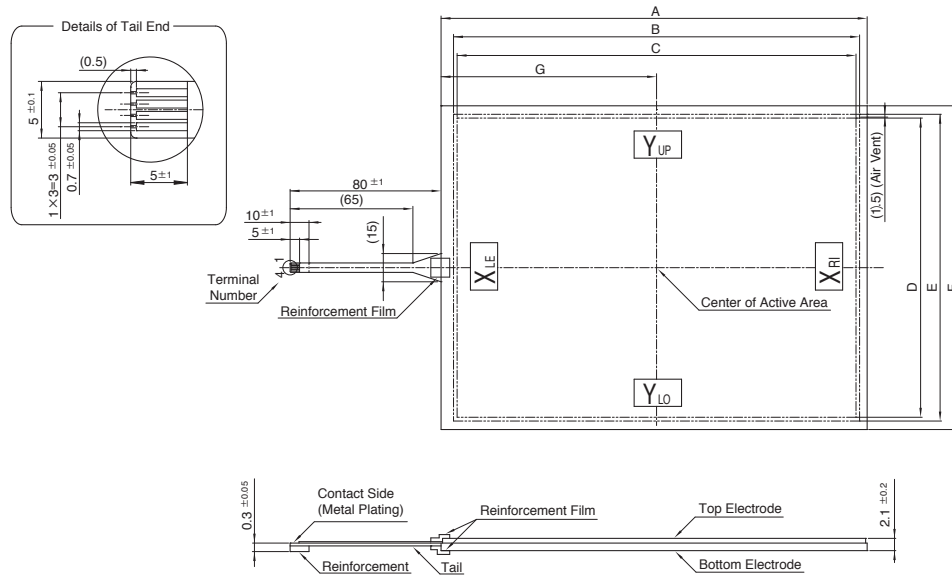

### Specifying circuit

Pins	Signal
1	Y <sub>UP</sub>
2	Y <sub>LO</sub>
3	X <sub>LE</sub>
4	X <sub>RI</sub>

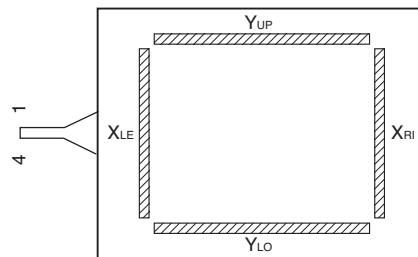

Y<sub>UP</sub>, Y<sub>LO</sub> : Bottom Electrode Contact  
 X<sub>LE</sub>, X<sub>RI</sub> : Top Electrode Contact

Model	Dimension A (mm)	Dimension B (mm)	Dimension C (mm)	Dimension D (mm)	Dimension E (mm)	Dimension F (mm)	Dimension G (mm)
TP02104A-4K	225.6±0.3	215	211.2	158.4	162.4	171.4±0.3	114.1
TP02121A-4K	260±0.3	249.6	245.8	184.3	188.1	198±0.3	131.5
TP02150A-4K	321.8±0.3	308.1	304.1	228.1	232.1	245.5±0.3	162.5
TP02190A-4K	395.5±0.3	382	376.3	301	307.4	321±0.3	198.1

## ▶ Control Board/Device Driver for Single Touch Screens

Combining an analog touch screen with a control board device driver on a computer enables you to perform the same operations as you would with a mouse simply by touching the touch screen.

Control Board		
Model	Interface	Type
TP02CS04CKS	RS232C	4-wire system (FPC tail)
TP02CU04CKS	USB	4-wire system (FPC tail)

System Configuration (for USB compatible system)

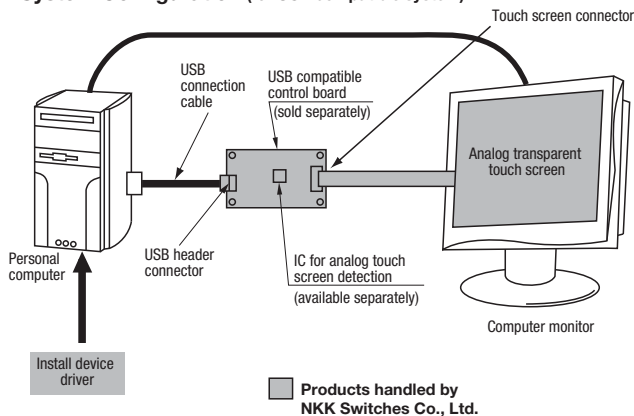

System Configuration (RS232C compatible)

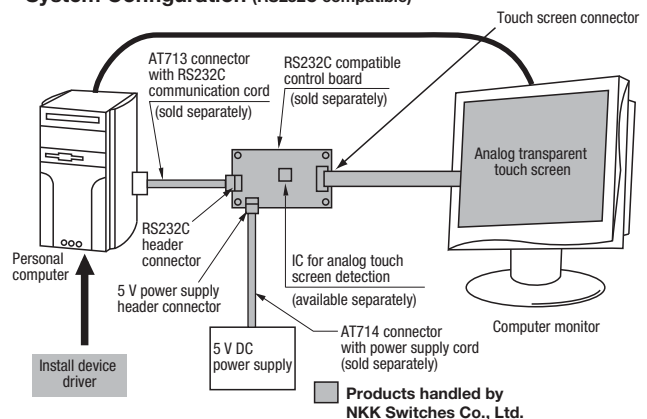

Basic Specifications		
Items	TP02CS04CKS	TP02CU04CKS
Interface	RS232C standard	USB 2.0 Full Speed
Clock	16 MHz	16 MHz
Power supply	5.0 V	5.0 V (USB bus power)
Resolution	10 bits	10 bits
Current consumption	40 mA or less	100 mA or less
Communication speed	9600 bps	
Communication format	Data length: 8 bits Parity bit: None Stop bit: 1	

Maximum Rating					
Items	Symbols	Rated value		Unit	Notes
		Min	Max		
Supply voltage	$V_{CC}$	-0.3	+5.5	[V]	
Input voltage	$V_{TP}$	—	$V_{CC}$	[V]	Touch screen input
	$*V_{RS}$	-15	+15	[V]	RS232C
Operating temperature	$T_{OPR}$	-20	+70	[°C]	No condensation
Storage temperature	$T_{STG}$	-25	+85	[°C]	No condensation

\* $V_{RS}$ : For RS232C compatible models only

Recommended Operation Conditions						
Items	Symbols	Rated value			Unit	Notes
		Min	Typ	Max		
Supply voltage	$V_{CC}$	+4.75	+5	+5.25	[V]	
Operating temperature	$T_{OPR}$	-20	—	+70	[°C]	No condensation

• For one-touch wiring, the RS232C control board comes with an analog-type 4-wire touch screen connector, an RS232C header connector, and a 5 V power supply header connector. Receptacle connectors integrated with RS232C cords (AT713) and receptacle connectors integrated with 5 V power supply cords (AT714) are available as options.

- \* Refer to the product specifications before using the TP02CS04CKS/TP02CU04CKS. To obtain product specifications, please contact our sales office.
- \* Please contact our sales office for inquiries regarding detection ICs for single touch screens.

## ▶ Device Driver for Single Touch Screens

< Device driver >

**Supported operating systems:** Windows 7/8/10  
Windows XPe CE

\* Windows is a registered trademark of Microsoft Corporation in the United States.

**Function:** Emulation software lets users perform operations via touch screens in place of a mouse.

**How to obtain the driver**

To download/obtain drivers, sign up on the NKK homepage or create a user account.



## ▶ Control Board for Single Touch Screens

### TP02CS04CKS (RS232C compatible)

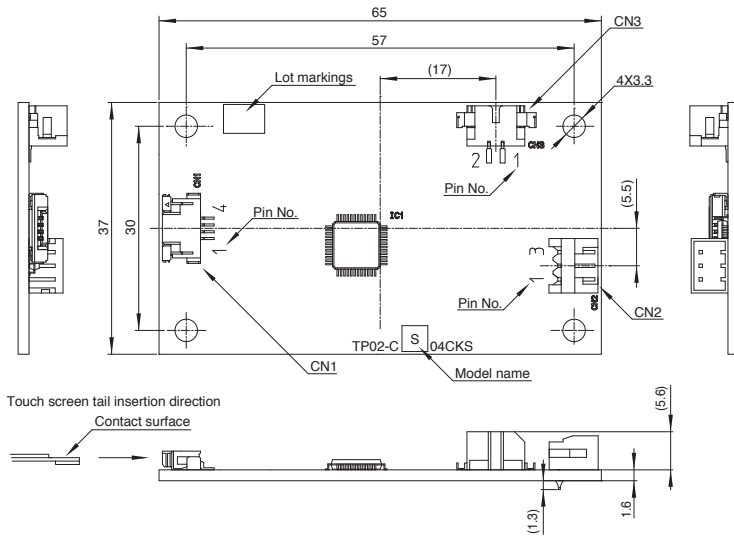

CN1 4-Wire analog touch screen connector (4-pin)

Pins	Symbol	Terminal name
1	Y0	For analog touch screen Y <sub>UP</sub> or Y <sub>LO</sub>
2	Y1	
3	X0	For analog touch screen X <sub>RI</sub> or X <sub>LE</sub>
4	X1	

CN2 RS232C header connector (3-pin)

Control board side			Computer side
Pins	Symbol	Terminal name	Connection terminal name
1	RD	Received data (IN)	Sent data
2	SD	Sent data (OUT)	Received data
3	GND	GND	GND

CN3 Power supply header connector (2-pin)

Pins	Symbol	Terminal name
1	V <sub>CC</sub>	Power supply voltage
2	GND	GND

### TP02CU04CKS (USB compatible)

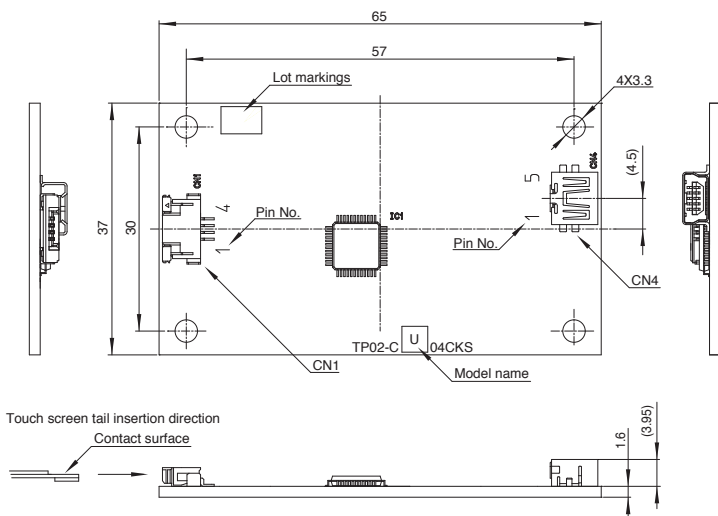

CN1 4-Wire analog touch screen connector (4-pin)

Pins	Symbol	Terminal name
1	Y0	For analog touch screen Y <sub>UP</sub> or Y <sub>LO</sub>
2	Y1	
3	X0	For analog touch screen X <sub>RI</sub> or X <sub>LE</sub>
4	X1	

CN4 USB header connector (5-pin)

Pins	Symbol	Terminal name
1	V <sub>CC</sub>	USB V <sub>CC</sub>
2	D -	USB D -
3	D +	USB D +
4	GND	USB GND
5	GND	Shield GND

### Receptacle connector with RS232C cord (AT713)

The **AT713** is a receptacle connector integrated with a cord used to connect the **TP02CS04CKS** control board to the PC for RS232C communications. The length of the cord can be specified by the customer. Excludes connector for PC side.

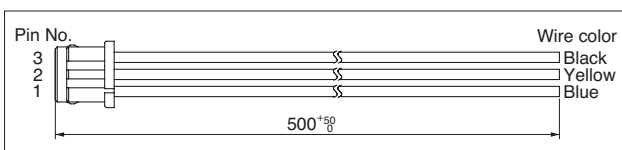

### Receptacle connector with power cord (AT714)

The **AT714** is a receptacle connector integrated with a cord used to connect the **TP02CS04CKS** control board to the power supply. The length of the cord can be specified by the customer.

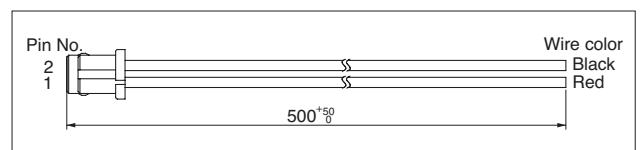

## ► Instructions

### Control Board Handling Precautions

- This product is not guaranteed to operate when combined with a touch screen manufactured by any company other than NKK Switches.
- Be careful of static electricity when handling this product, and ensure workers and working areas where this product is handled are earthed.
- Do not turn on the power supply to this product until it is connected to both the host and touch screen.
- When connecting or disconnecting the CN1 connector of this product and touch screen tail section, be sure that the CN1 connector slider is pulled back, and refrain from connecting or disconnecting more than 10 times.
- Never attempt to modify this product.
- The content of this product may be changed at the manufacturer's discretion for improvement purposes without prior notification.
- Do not use commands other than those prescribed in the specifications with this product.
- NKK Switches cannot accept any responsibility whatsoever for any damages that occur through the use of this product.
- The tail used to connect the touch screen unit and control board is susceptible to noise, and should therefore be installed as far away as possible from noise sources (LCD drive inverter, etc.).
- This product is covered under warranty for 1 year from the date of purchase.

### Precautions for Installation

- Make sure that the case or housing does not place unnecessary stress on the product causing it to distort.
- The tail section is the weakest part of the product and may disconnect easily. Therefore, do not pull on or place stress on the tail section.
- Do not place excessive stress (sufficient to leave a bend line) on the tail section. Doing so may cause disconnection or increased resistance value.
- When installing glass products in particular, be sure to consider vibration and impact during installation.
- Install the touch screen securely so there is no looseness. Looseness may cause detection to become unstable. In particular, looseness has an adverse effect on detection performance of analog types during operation.
- Make sure there is no burring, etc. at the edges of the case and housing. Burring may cause misoperation. Furthermore, ensure that the edges of the case and housing do not enter the key area. Doing so may cause misoperation due to the edges of the case or housing.
- Leave a space (approx. 0.5 mm) between the case or housing and top electrode to ensure there is no differential shrinkage in the case, housing or top electrode, and no effects from distortion or deformation. When installing buffer material in the space, make sure that the top electrode is not forcibly pushed. Forcibly pushing the top electrode or fixing with double-sided tape, etc., may cause the top electrode to distort or flex, which has an adverse effect on the external appearance and functionality of the product. Install buffer material more than 0.6 mm to the inside of the A section.

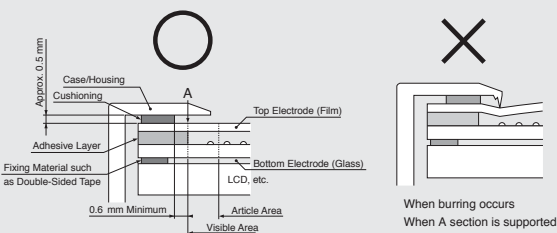

- In cases where external pressure may be placed on the periphery during operation such as the case or housing section being held by hand, make sure that the touch screen is not input due to distortion of the edges of the case or housing.
- When fixing the touch screen in place, fix it using the bottom section such as by fixing it to the LCD. Fixing the top electrode to the case or housing with double-sided tape, etc. causes stress to be placed on the connection between the top and bottom electrodes, which may cause damage or distortion to the film or malfunctions.
- Some products have an air vent installed to ensure that the inner and outer pressure of the touch screen are the same. Make sure that this is not blocked when installing. Furthermore, ensure that liquids such as water and oil do not enter the product through the air vent or product exterior (connection section between the top and bottom electrodes).
- Avoid any situation where air pressure from a device attached to the touch screen could pass through the air vent and cause the top electrode to swell. Doing so may affect the product such as reducing the lifespan of the product. Furthermore, reducing the pressure in the touch screen through the air vent may cause interference fringe or constant input to occur.
- Please note that moisture from condensation, etc. on the tail connection section or edges may result in migration, causing short circuit failure to occur.

### Handling Precautions

- When unpacking the product, make sure the product is facing in the correct vertical/horizontal orientation. Furthermore, glass edges have not been chamfered and may be sharp. Be sure to wear gloves when handling the products to avoid cuts.
- Do not use a clamp to lift or pull the tail section. Doing so may result in damage to the tail connection section.
- Wear gloves or fingerstalls to prevent the fingerprints or dirt from getting onto the product.
- When holding the product, hold it outside of the range of the visible area.
- To remove dirt from the surface of the product, wipe gently with a soft cloth soaked in ethanol. Do not use anything other than ethanol.
- When storing the product, wrap it in the same packaging as when it was purchased and within the temperature and humidity conditions prescribed in the specifications.
- Do not store the product in an acidic environment or near other corrosive gases.
- Do not store the product in locations where condensation may occur.
- Do not stack products or place other items on the products, as doing so places excess load on the products, which may result in deformation or bending of the products or scratches to the edges of the products.
- The product has a protective film attached. Do not remove this film until immediately before use to prevent the product from becoming scratched, etc. However, storing the product with the protective film attached for prolonged periods may result in the adhesive from the protective film becoming attached to the product.

### Precautions for Operation

- Do not operate the product with anything other than your finger or a specialized input pen (commercially available polyacetal pen). In particular, do not use sharp objects such as a ballpoint pen or mechanical pencil. Doing so may cause scratches to the surface, malfunctions and cracked glass.
- The area between the visible area and key area is structurally weak. Do not rub harshly with a pen, etc.

(Continued on next page)

## Design Precautions

- The input position of analog type products may become misaligned due to resistance value differences between individual products, or changes to the resistance value due to age deterioration. Be sure to enable calibration using both hardware and software to calibrate the input position.
- When installed onto a display device such as an LCD, noise generated by the display device may cause malfunction. Implement noise countermeasures such as connecting the frame of the display device to ground.
- The contact resistance of the product changes when pressed by a finger or pen. Ensure that data is read when the contact resistance is stable, such as by ignoring data read when the contact resistance is unstable.
- Data becomes broken on the dot spacer of analog type products when used for drawing lines, etc., and must be corrected using software.
- Be sure to evaluate sufficiently when using double-sided tape or adhesive to attach the top electrode to the surface sheet. Distortion, etc. of the top electrode or surface sheet may have an adverse effect on functionality.

## Precautions for Use

- Products are guaranteed based on the evaluation of product standards within the moisture tolerance and usage temperature range, but are not guaranteed to operate perpetually at this temperature.
- Touch screens have individual differences. Therefore, calibration data from one touch screen should not be applied to other touch screens, and calibration should be implemented for each touch screen.
- If the connector is removed and reconnected from the tail after calibration, perform calibration again.
- The prescribed specifications are a guarantee of product quality on a single touch screen. When using the product, be sure to confirm and evaluate performance when attached to your own products.

# Broadening the World of Touch Screens with Precisely Designed Resistive Film from a Specialist in Industrial Switches

**For operation that feels light to the touch**  
Series TP02 4-Wire Analog

**4:3**

10.4" 12.1" 15" 19"

**Wide**

10.6" 12.1" 15.6"

**For motion-sensitive operation**  
Series TP02 4-Wire Analog

**4:3**

10.4" 12.1" 15" 19"

**Wide**

10.6" 12.1" 15.6"

**Control Board** **IC**

**If dedicated IC is not required**  
Series FT Digital

5.7"

**NKK Supplies a Wide Range of Touch Screens to Meet the Needs of All Different Customers**

**For high durability**  
Series FT 5-Wire/8-Wire Analog

**4:3**

10.4" 12.1" 15"

**Control Board** **IC**

\* The 8-wire analog type is custommade. All sizes of the 4-wire type support an 8-wire conversion tail.

**For a wide range of sizes and excellent cost performance**  
Series FT, 4-Wire Analog, Printed Tail

**4:3**

5.7" 6.5" 8.4" 10.4" 12.1"

15" 19"

**Wide**

10.6" 12.1" 15.6"

**Control Board** **IC**

**For high contact reliability**  
Series FT, 4-Wire Analog, FPC Tail

**4:3**

5.7" 6.5" 8.4" 10.4" 12.1"

15" 19"

**Wide**

10.6" 12.1" 15.6"

**Control Board** **IC**

\* Specifications presented here are subject to change without prior notice. Check with our sales office for the latest specifications.

## NKK SWITCHES CO., LTD.

European Office:  
Mergenthalerallee 10-12, 65760 Eschborn, Germany  
Tel: +49 61 96 400-189(English, German)  
www.nkkswitches.eu E-mail: contact@nkkswitches.eu